

Monaco Dolls Pram Stroller with Bag

Instruction manual



**IMPORTANT - RETAIN FOR FUTURE
REFERENCE, READ CAREFULLY.**

Warning: A child's safety is your responsibility.

This product is tested and approved to
EN 71

1. Welcome

Thank you for purchasing the Puggle Monaco Dolls Pram Stroller with Bag. Please read the instructions and warnings carefully before use to ensure safe and satisfactory operation of your Puggle Monaco Dolls Pram Stroller with Bag.

If you have a query with this product or require replacement parts, please contact Online4baby online at online4baby.com/contact-us.

2. Safety instructions

IMPORTANT! PLEASE READ THE FOLLOWING INSTRUCTIONS CAREFULLY BEFORE INSTALLING THE PRODUCT.

- **WARNING!** Keep for future reference. The child may be hurt if you do not follow these instructions.
- **WARNING!** Choking hazard due to small parts.
- **WARNING!** This stroller is not suitable for children under 36 months.
- **WARNING!** This product is a toy and is not suitable for carrying babies, children or pets.
- **WARNING!** Assembly should be carried out by an adult to prevent the item collapsing during use.
- **WARNING!** Please remove all packaging before giving this item to a child.
- **WARNING!** Adults should check the product regularly to prevent collapsing during play.

3. Parts List

A

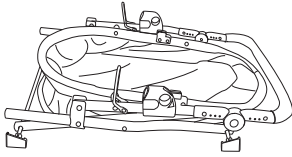

B



C



D



E

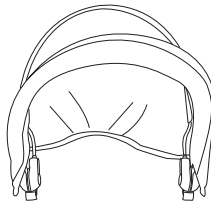

F

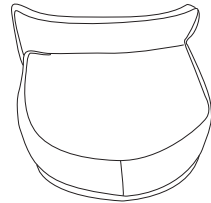

G



Contained in your carton are:

N ^o	Part	Qty
A	Chassis and body	1
B	Wheel	4
C	Wheel clip	4
D	Wheel cap	4
E	Canopy	1
F	Apron	1
G	Bag	1

4. Assembly

4.1. CHASSIS ASSEMBLY

Lift the handle to open and unfold the stroller.

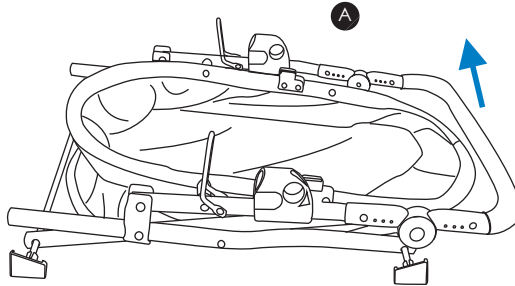

Align the frame locks with the frame tube on either side and press down until secure.

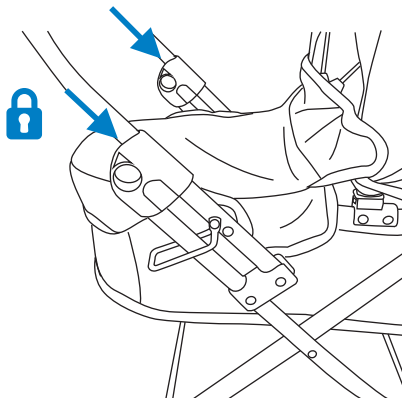

4. Assembly

4.2 WHEEL ASSEMBLY

Remove the axle protector from the axle wheel pins.

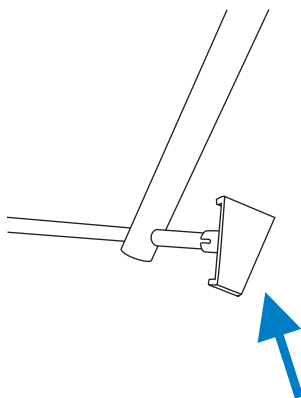

Push the wheel (B) onto the axle pin.
Secure the wheel in place using a wheel clip (C).
Finally attach the wheel cover (D)

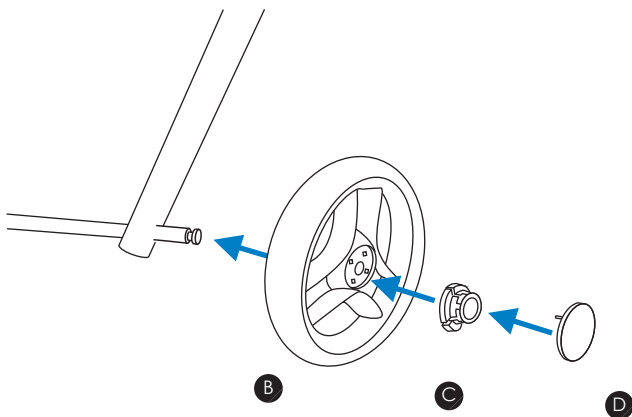

4. Assembly

4.3. CANOPY ASSEMBLY

Thread the canopy (E) connectors through the holes located on the body to fix on the handle. Ensure the runners are level to the rivet cap.

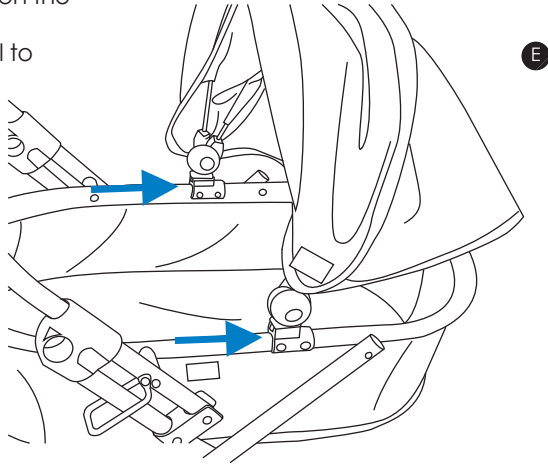

4.4. APRON

Attach the apron around the top frame of the body.

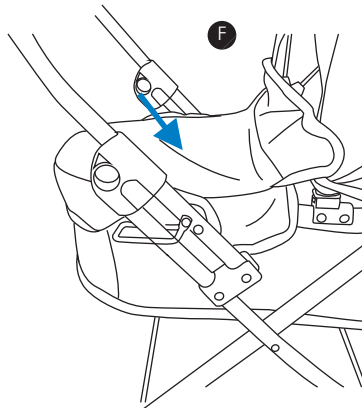

5. Handlebar Adjustment

5.1. HANDLEBAR ADJUSTMENT

Adjust the height of the handle by pressing the handlebar height adjustment buttons located on either sides of the handlebar. At the same time adjust the handle up or down. Release buttons at your desired position. The handlebar will "click" into place.

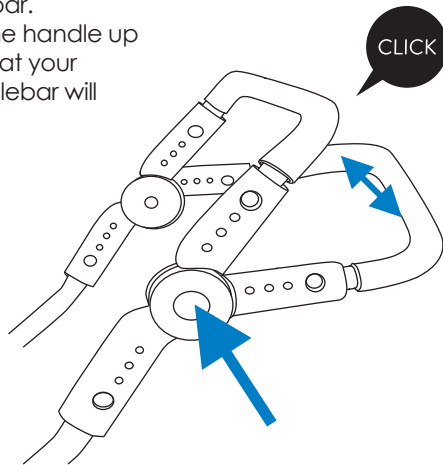

6. Folding

6.1 FOLDING CHASSIS

Release the safety locks after the frame locks.

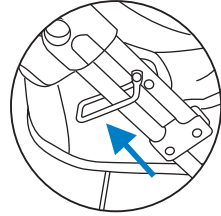

Then pull up the frame locks on either side to release the frame.

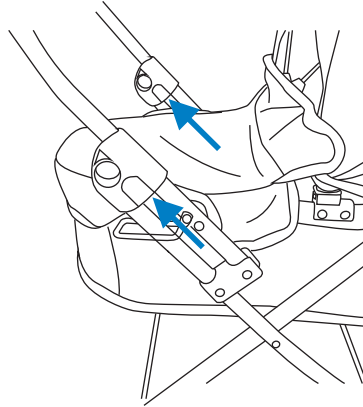

Push the handlebar forward and down to close the frame.

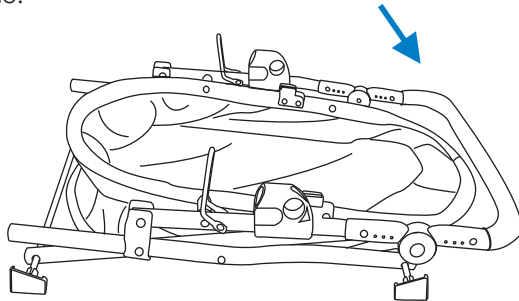

7. Care and Maintenance

7.1. CLEANING



- Spot or sponge clean fabrics with mild detergent. Use mild soap or upholstery shampoo. NEVER use bleach. Dry in shade thoroughly before reuse and avoid direct heat and sunlight. Do not iron. Do not dry clean.
- Wipe clean plastics and metals with a damp cloth.
- Never clean any part of the product with abrasive, ammonia based, bleach based or spirit type cleaners.
- Ensure the product is fully dry before use or storage.
- Always ensure the product is stored in a dry place to prevent mold or mildew developing.

7.2. MAINTENANCE

- The product requires regular maintenance to ensure correct and safe performance.
- Regularly inspect the joints and fixings to ensure they are clean, operating correctly and in full working order.
- Do not use this product if any part is broken, torn or missing and use only spares provided by the manufacturer.
- If parts become stiff or difficult to operate, ensure dirt is not the cause, then try a light application of a silicon lubricant, ensuring it penetrates between the components. Regular lubrication of moving parts will extend the life of your product and make opening and folding easier.
- After exposure to damp conditions, dry off with a soft cloth and leave fully open in a warm environment. Storing damp will encourage mildew to form.
- Store in a dry place.
- Do not leave in sunlight for prolonged periods as some fabrics may fade.



If you have any questions or concerns regarding this product,
do not hesitate to contact our expert team online
via online4baby.com/contact-us

Feeling social?  
online4baby.com

Imported by Online4baby Ltd,
Meadowbank, Tweedale Way, Oldham, OL9 8EH