

## Prestbury Classic Luxe Sleigh Cot Bed

Instruction manual

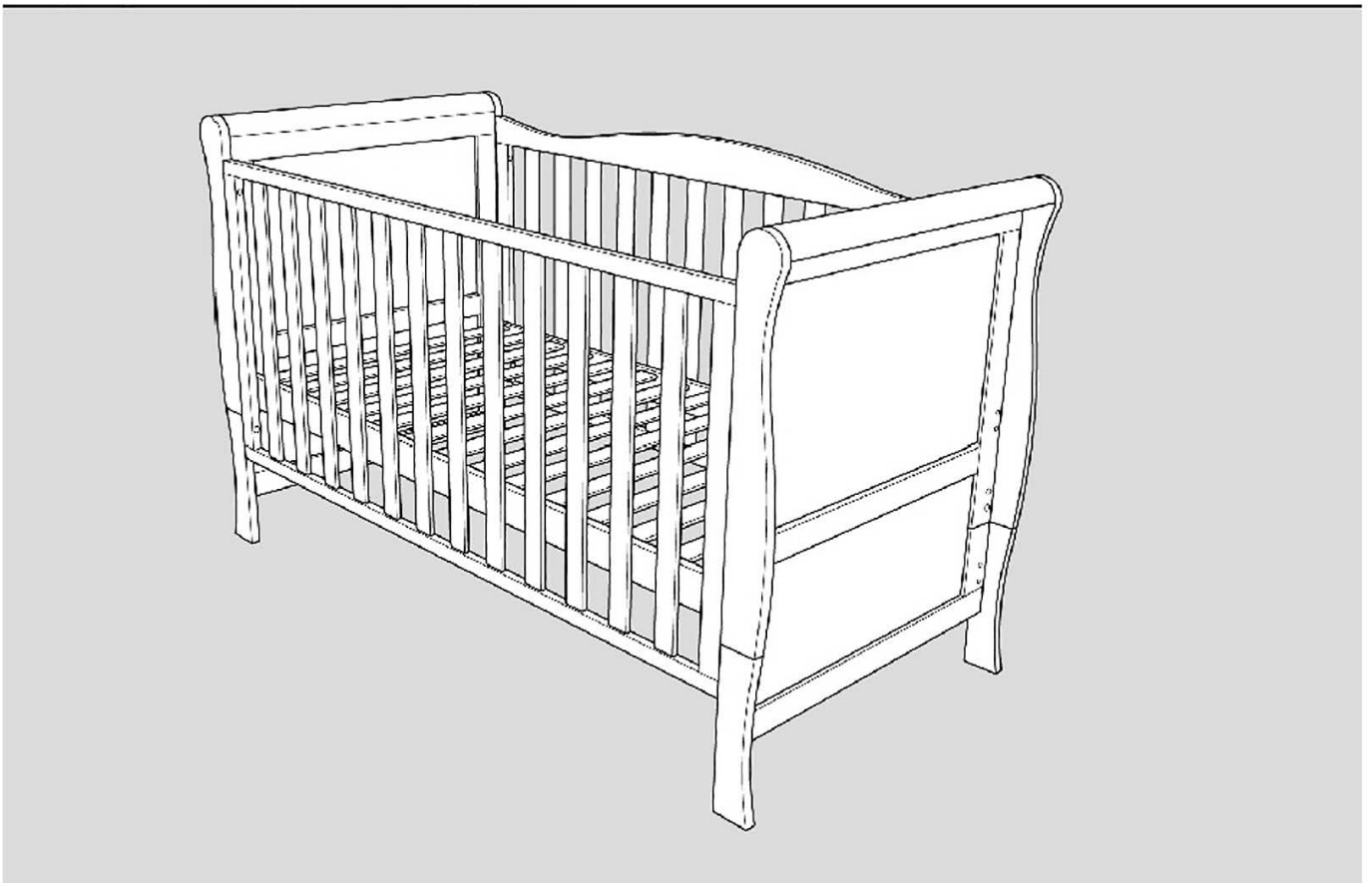

**IMPORTANT – Please read these instructions carefully before use and retain for future reference.**

This Puggle Cot Bed conforms to BS EN 716-1:2017+AC:2019 and the Toddler Bed conforms to BS 8509:2008+A1:2011

# Safety Instructions

**IMPORTANT – Read the instructions carefully before use and keep for future reference.**

- **WARNING:** A child's safety is your responsibility.
- **WARNING:** Be aware of the risk of open fire and other sources of strong heat, such as electric bar fires, gas fires, etc. in the near vicinity of the cot.
- **WARNING:** Do not use the cot if any part is broken, torn or missing and use only additional or replacement parts obtained from the manufacturer or distributor.
- **WARNING:** Do not leave anything in the cot or place the cot close to another product, which could provide a foothold or present a danger of suffocation or strangulation, e.g. strings, blinds/curtain cords etc.
- **WARNING:** Do not use more than one mattress in the cot.
- **WARNING:** Do not place this cot bed in close proximity to heat sources, windows and other furniture e.g. open fires, radiators, gas and electric heaters etc.
- The lowest cot base position is the safest. The base should always be used in the lowest position as soon as the baby is old enough to sit up.
- The thickness of the mattress used shall be such that the internal height (surface of the mattress to the upper edge of the cot frame) is at least 500mm in the lowest position of the mattress base and at least 200mm in the highest position of the mattress base. Maximum thickness of 100mm.
- All assembly fittings should always be tightened properly, checked periodically and the care should be taken that no bolts are loose, because a child could trap parts of the body or clothing (e.g. strings, necklaces, ribbons for babies' dummies), which could pose a risk of suffocation and strangulation.
- The safety of the cot could be adversely affected by fitting flammable drapes.
- To prevent injury from falls, when the child is able to climb out of the cot bed, the cot bed should be converted into a toddler bed.
- Recommended mattress size is 140 x 70cm and shall be such that the gap between the mattress and the sides and ends does not exceed 30mm.
- This Puggle Cot Bed conforms to BS EN 716-1:2017+AC:2019 and the Toddler Bed conforms to BS 8509:2008+A1:2011.
- The Cot Bed is suitable from birth. When the cot is converted to toddler bed mode, the minimum age should not be less than 18 months and the maximum age should not be more than 4 years old.
- Children are likely to play, bounce, jump and climb on beds, therefore the child's bed should not be placed too close to other furniture or windows, blind cords, curtain pulls or other strings or cords and should be placed either tight to any wall or have a gap of 30cm between the wall and the side of the bed.

## Welcome

Thank you for purchasing the Puggle Prestbury Classic Sleigh Cot Bed.

Please read these instructions and safety warnings carefully before use to ensure safe and satisfactory operation of this product.

Your child's safety is your responsibility. If you have a query with this product or require replacement parts, please contact Online4baby online at [online4baby.com/contact-us](http://online4baby.com/contact-us).

**WARNING!** Assembly by an adult. Keep away from children until fully assembled. Keep children clear during assembly as pack contains small parts which may present a choking hazard.

Lay out the parts on a soft level surface and compare to the part/fixings checklist. Do not discard any packaging until you are sure that you have all the parts.

This bed is designed to be easily dismantled for storage or transportation.

## Before Assembly

Before assembly, please ensure that you have read and understood the instructions. The carefully unpack our cot bed and ensure that all parts are present, please see parts list as follows.

Discard packaging in accordance with your local authority guidelines.

We advise that the cot bed should be assembled in the room where it is intended to be used, two person assembly is recommended. The cot bed should be assembled on a clean surface, free from any sharp objects that could mark or damage the product.

**CAUTION:** There are many small components used in the construction of this cot bed. These items should be kept out of reach of young children whilst assembling the unit.



2 Man assembly recommended, approximate build time 30 minutes



# Parts List

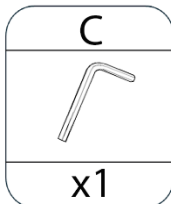
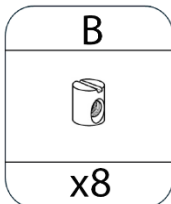
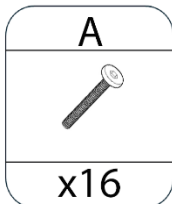
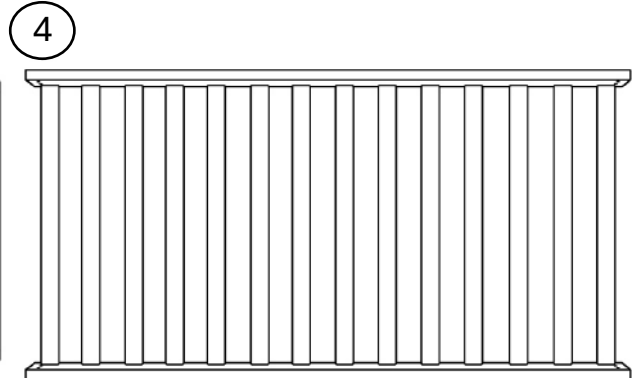
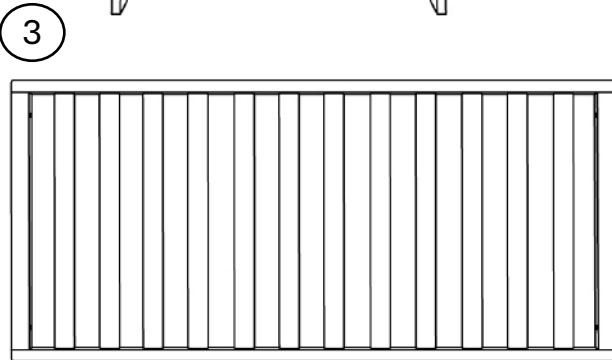
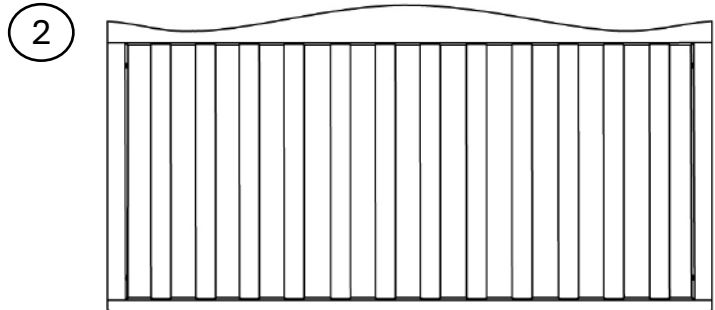
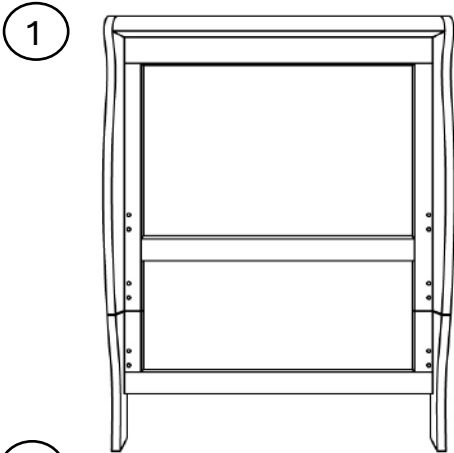

## Parts included with your Prestbury Sleigh Cot Bed are:

Part.	Description	Qty
1	Cot Ends	2
2	Cot Side – Rear	1
3	Cot Side – Front	1
4	Cot Base	1
A	Bolts	16
B	Barrel Nuts	8
C	Allen Key	1

## Assembling the Cot Bed

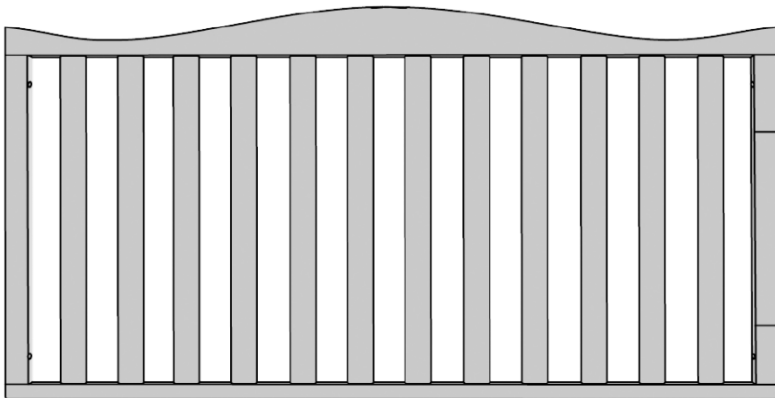

1. Lay the Rear Cot Side (2) on the floor on a soft surface so that the height marks (i) and (ii) are facing you.

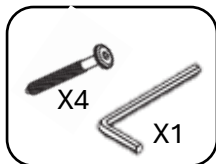

2. Attach the Cot End (1) to the Rear Cot Side (2) using the Bolts (A) and tighten using the Allen Key (C).
3. Repeat the above step for the remaining Cot End (1)

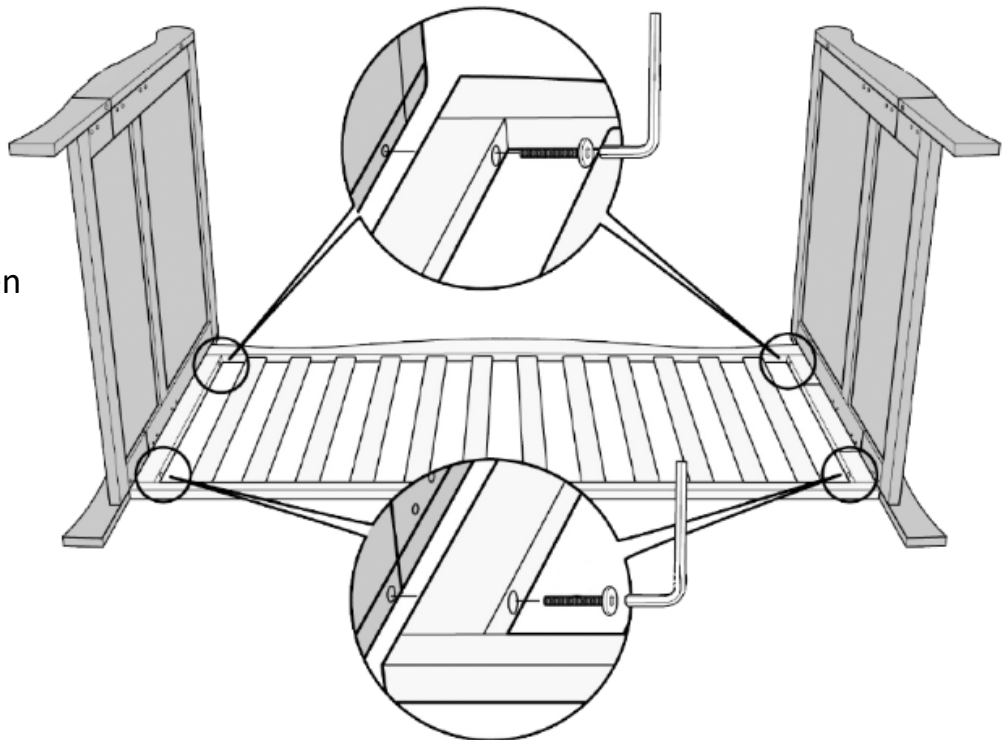

**IMPORTANT!** The cot should be handled carefully at this stage. Do not push or pull the cot ends and do not attempt to stand the incomplete cot upright.

## Assembling the Cot Bed

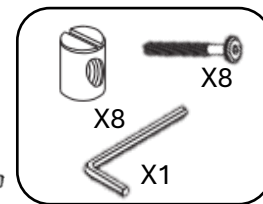
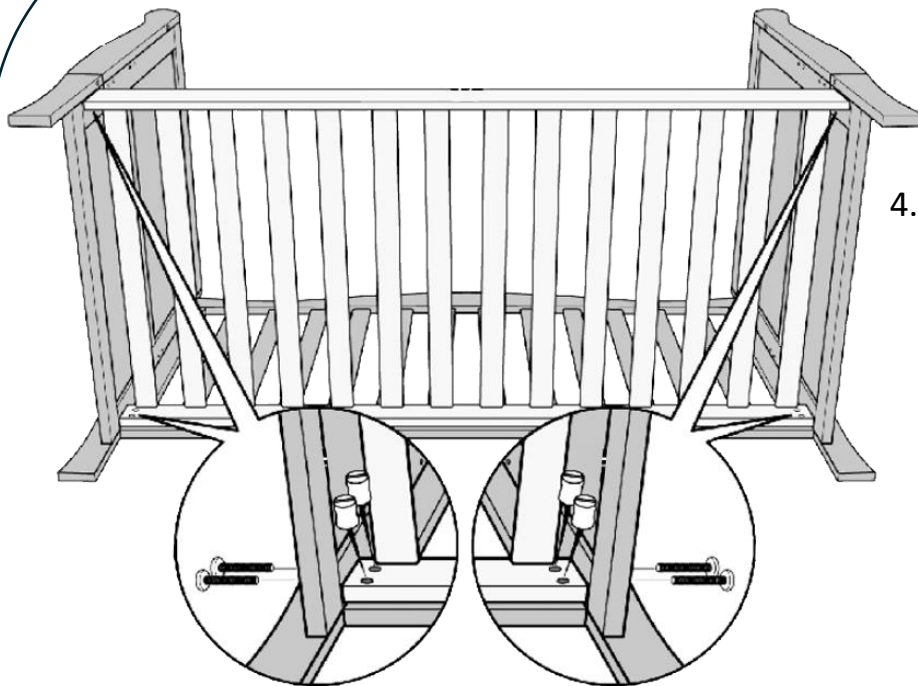

4. With the cot still on its side, carefully place the Cot Base (4) in between the Cot Ends (1) at the desired height. Fix into place using the Bolts (A), Barrel Nuts (B) and tighten with the Allen Key (C).

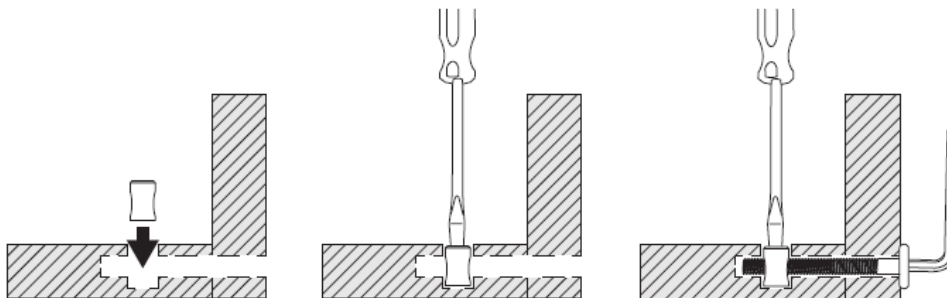

- Insert the Barrel Nut (B) into the hole shown in the instruction step.
- Use a flat headed screwdriver (not supplied) to align the Barrel Nut (B).
- Insert the Bolt (A) and use the Allen Key (C) to screw into the Barrel Nut (B).

**NOTE:** The Base Panel can be adjusted as there are 3 height settings, the above shows the lowest. The lowest base position is the safest and should always be used as soon as your child is old enough to sit up.

**WARNING:** DO NOT use power tools to tighten bolts only use the Allen Key (B) provided.

## Assembling the Cot Bed

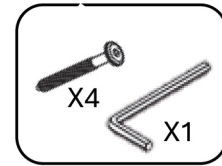
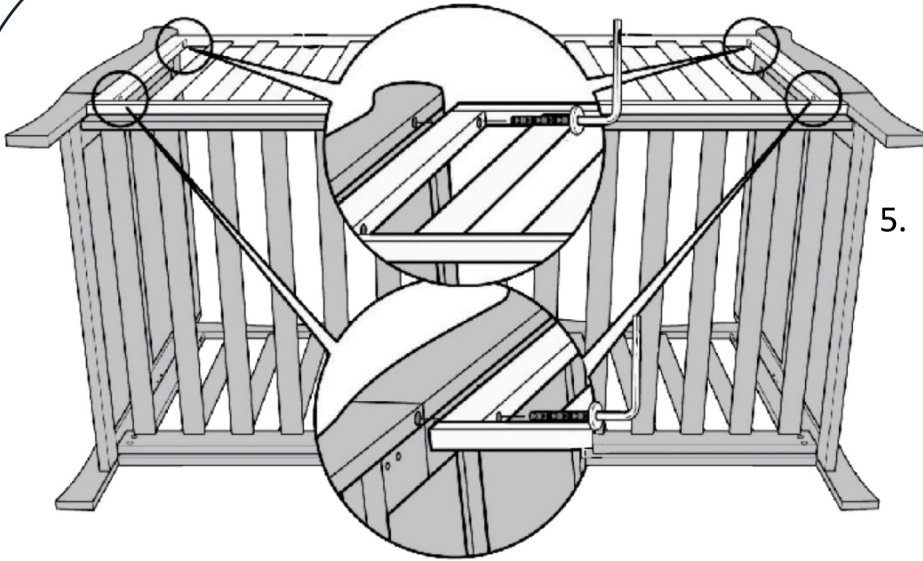

5. Attach the Front Cot Side (3) to the Cot Ends (1) using the Bolts (A) and tighten using the Allen Key (C).

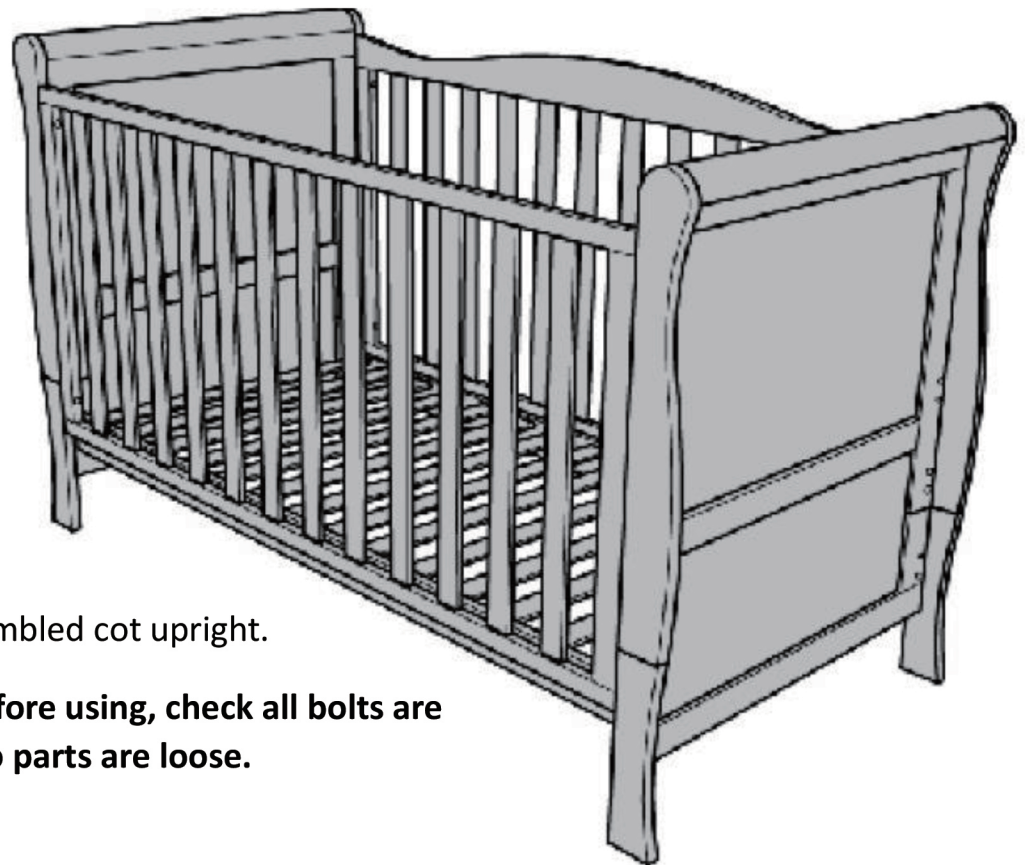

6. Turn the assembled cot upright.

**IMPORTANT! Before using, check all bolts are tight and that no parts are loose.**

## Assembling the Toddler Bed

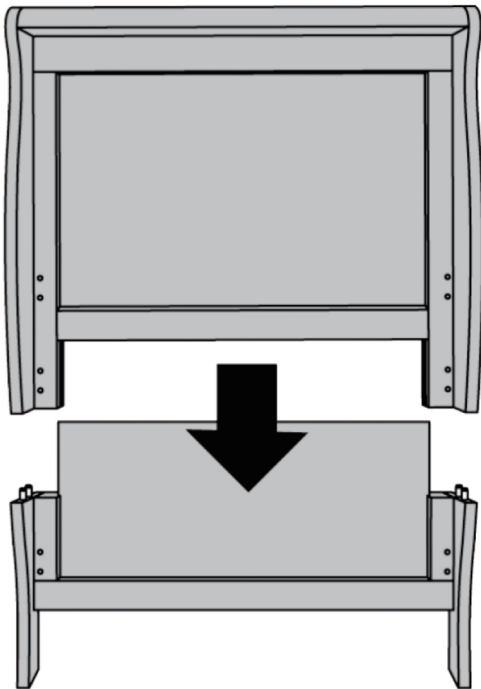

7. Split the Cot End (1) into the top and bottom panel. Store the bottom panel of the Cot End (1) away in a cool, dry place.

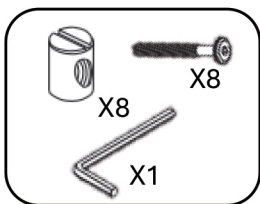

8. With the Cot Ends (1) on their side, carefully place the Cot Base (4) in between the Cot Ends (1) at the desired height. Fix into place using the Bolts (A), Barrel Nuts (B) and tighten with the Allen Key (C).

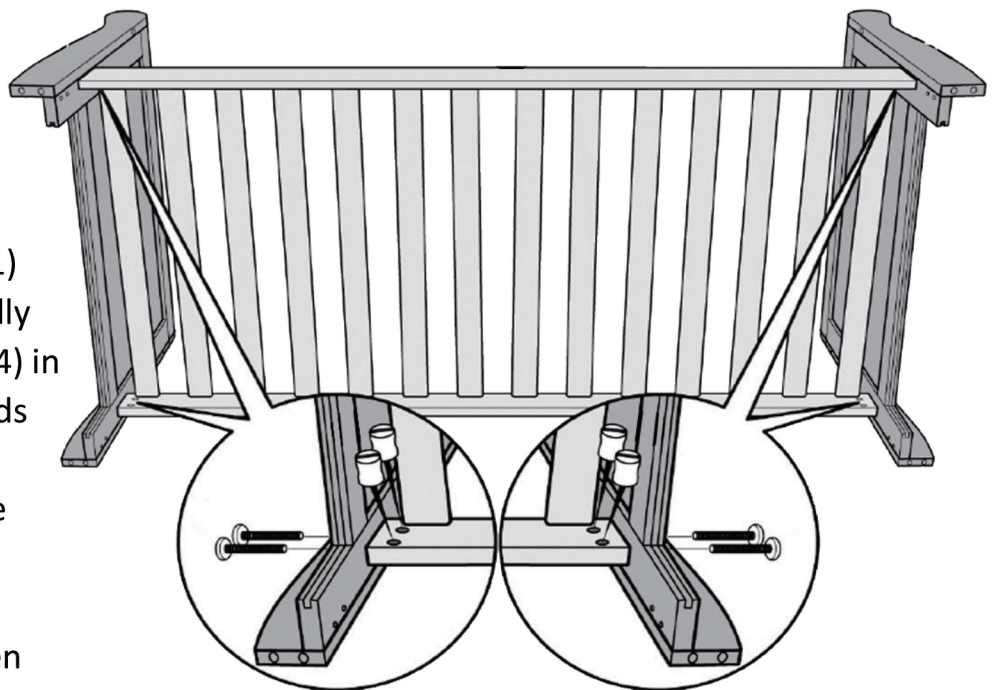

**IMPORTANT! When in toddler bed mode DO NOT use the lowest base position. This applies ONLY in bed mode.**



## Assembling the Toddler Bed

9. Turn the assembled toddler bed upright.

**IMPORTANT!** Before using, check all bolts are tight and that no parts are loose.

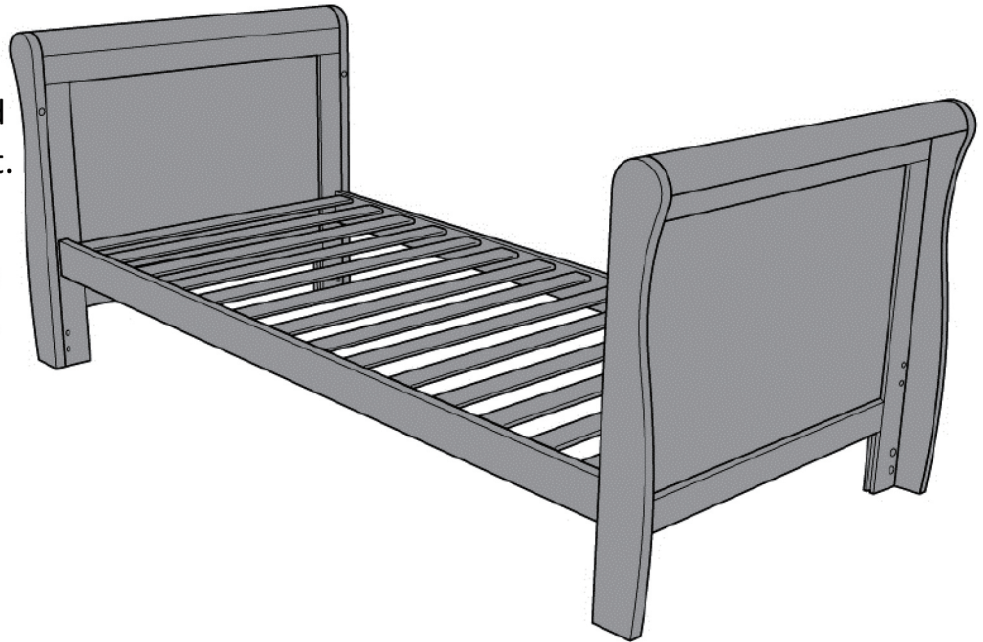

## Assembling the Day Bed

10. To use as a Day Bed, follow the Cot Bed assembly steps 1 to 4, ensuring that the base is attached in step 4 in the lowest position.

**IMPORTANT!** Before using, check all bolts are tight and that no parts are loose.

**WARNING!** Never use the day without at least one cot side attached.

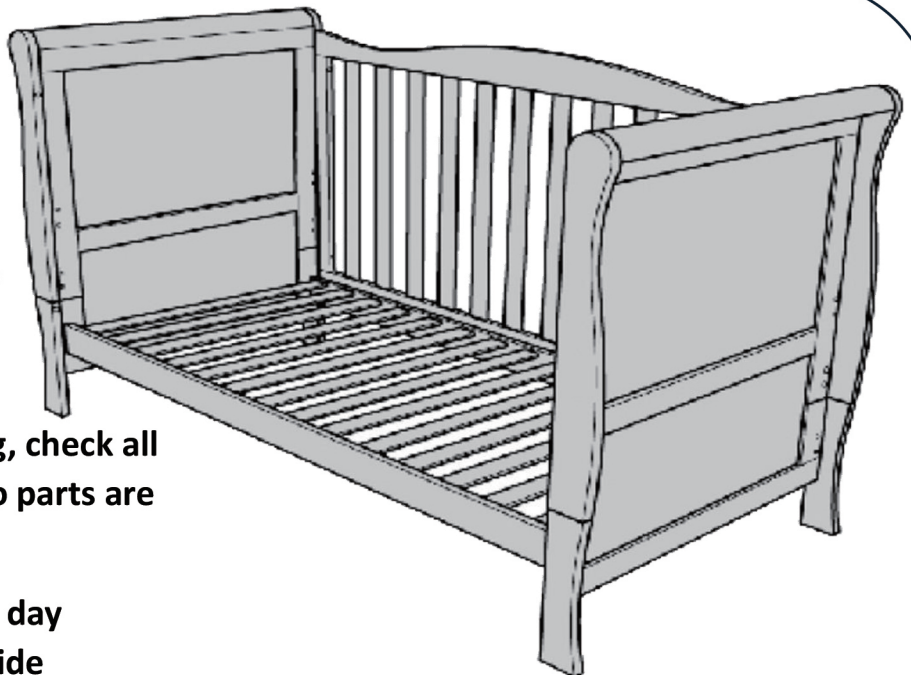

## Adjusting the base height

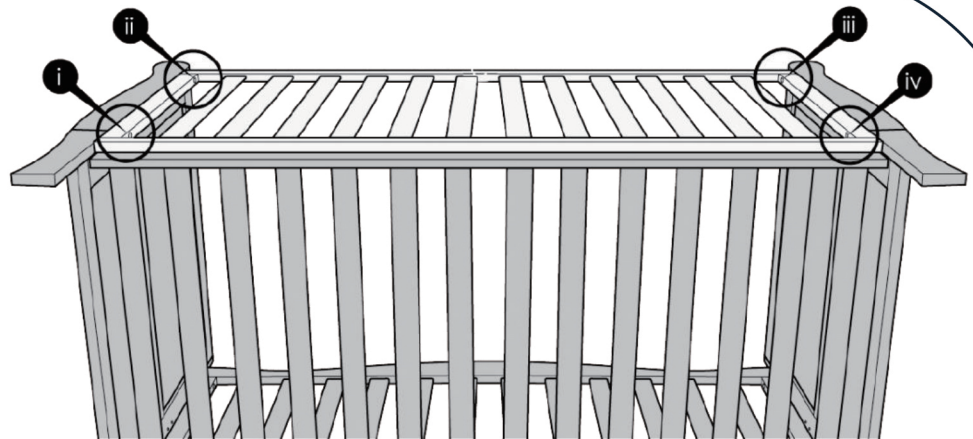

11. Remove any bedding and mattress from the cot. Loosen all bolts by 2 to 3 turns, as this will help when removing the sides and moving the base up or down. Carefully turn the cot on its back so that the Front Cot Side (3) is uppermost. Fully undo the Bolts shown as (i), (ii), (iii) and (iv) above and remove the cot side.

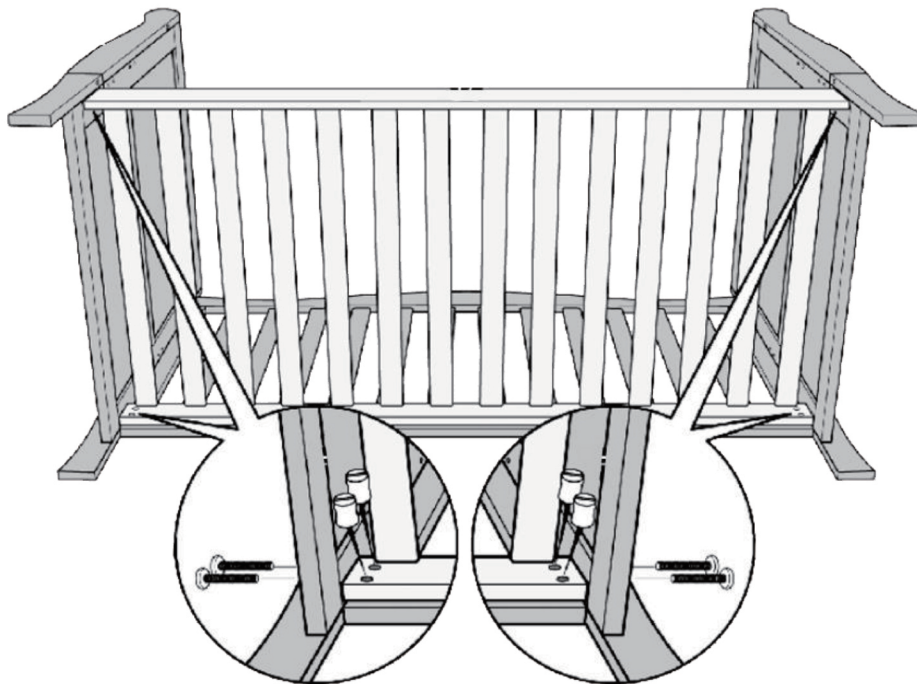

12. Remove the Bolts (A) and Barrel Nuts (B) that hold the Cot Base (4) in place. Reposition the Cot Base (4) to your desired height and then re-attach the Cot Base (4) to the Cot Ends (1) using the Bolts (A), Barrel Nuts (B) and then tighten with the Allen Key (C).

## Care and Maintenance

- Scuff marks may be removed with a soft, damp cloth.
- Occasional use of furniture polish will maintain the finish of your cot bed.
- DO NOT use harsh or abrasive cleaners or bleaches on this product, as they may damage the finish.
- Periodically check all fixings to ensure they remain tight and tighten where required.

# puggle™

---

Feeling social?  

[online4baby.com](https://www.online4baby.com)

Imported by Online4baby Ltd.

Meadowbank, Tweedale Way, Oldham, OL9 8EH